



[TRACE32 Online Help](#)

[TRACE32 Directory](#)

[TRACE32 Index](#)

TRACE32 Documents		
Intel® DCI [Direct Connect Interface]		
Debugging via Intel® DCI User's Guide	1	
History	3	
Introduction	4	
4-wire DCI OOB	4	
DCI OOB Hardware	5	
DCI DbC	6	
Target System Requirements	7	
Related Documents	7	
Start a TRACE32 Session using Intel® DCI	8	
Prepare Your Target	8	
Connecting to an Intel® SoC using DCI OOB	8	
Connecting to an Intel® Client or Server System using DCI OOB	9	
Connecting to an Intel® SoC using DCI DbC	10	
Connecting to an Intel® Client or Server System using DCI DbC	11	
Troubleshooting	12	
DCI error: no response to connect pattern	12	
Could not stop the target	12	
Target Power Fail	12	
Intel® DCI Specific Commands	13	
DCI	Commands to configure the Intel® DCI trace handler	13
DCI.DESTination	Set trace destination	13
DCI.ON	Enable trace handler	13
DCI.OFF	Disable trace handler	14
SYStem.DCI	Intel® DCI specific SYStem commands	15
SYStem.DCI.Bridge	Select DCI bridge	15
SYStem.DCI.BssbClock	Configure DCI OOB clock rate	15
SYStem.DCI.CKDlrouting	Routing of the CK and DI signals	16
SYStem.DCI.DisCONnect	Force DCI disconnect	16
SYStem.DCI.DOrouting	Routing of the DO signals	17
SYStem.DCI.PortPower	Configure VBUS	18
SYStem.DCI.TimeOut	Configure timeouts of internal operations	19

Intel® DCI Specific Functions	20
In This Section	20
SYStem.DCI.Bridge()	Currently selected DCI bridge 20
SYStem.DCI.BssbClock()	Currently selected DCI OOB clock 20
SYStem.DCI.TIMEOUT()	Timeouts of internal operations 21

History

24-May-19 Added description of the command `SYStem.CONFIG DCI.TimeOut` and function `SYStem.DCI.TIMEOUT()`.

Introduction

The Intel® Direct Connect Interface (DCI) allows debugging of Intel® targets using the USB3 port. The technology supports debugging via the USB Stack (DCI DbC) as well as a dedicated protocol using a USB3 connector only (DCI OOB).

4-wire DCI OOB

DCI OOB uses a special protocol on the USB3 pins. This makes the mode independent of the actual USB implementation on the target board. This allows debugging of cold boot scenarios, reset flows, and sleep states.

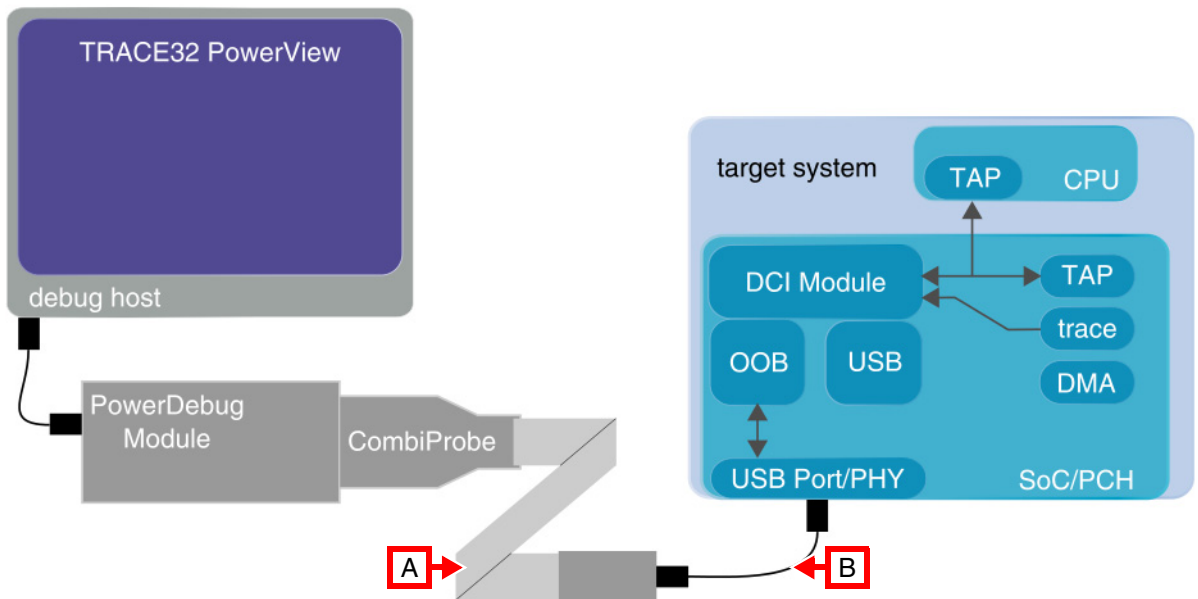

The figure above illustrates a typical setup. A Power Debug Module with a CombiProbe and a Whisker Cable DCI OOB (LA-4515) [A] is connected to the debug host running TRACE32 PowerView. On the target side the Whisker Cable DCI OOB connects to a USB port of the target system using a short USB cable [B].

TRACE32 sends DCI commands encoded in the DCI OOB protocol to the target system. In the target system the commands are decoded by the OOB module and forwarded to the DCI module where they are translated to JTAG sequences. These JTAG sequences allow to access the internal TAP of the SoC/PCH as well as externally connected JTAG devices (e.g., the CPU of a client or server system).

Trace data can be exported through the DCI module and recorded by the CombiProbe.

DCI OOB Hardware

In the following the available DCI OOB hardware is shown.

Whisker Cable DCI OOB for CombiProbe Version 1

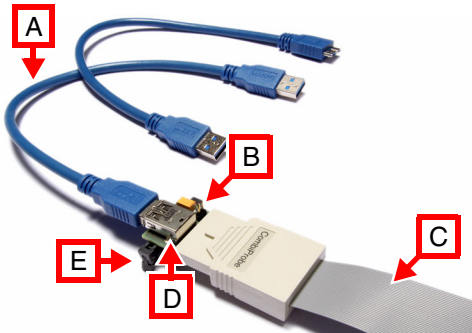

- A USB cable to target system
- B VBUS jumper
- C Cable to CombiProbe

- D USB connector for target system
- E 34-pin expansion connector (proprietary)

Whisker Cable DCI OOB for CombiProbe Version 2

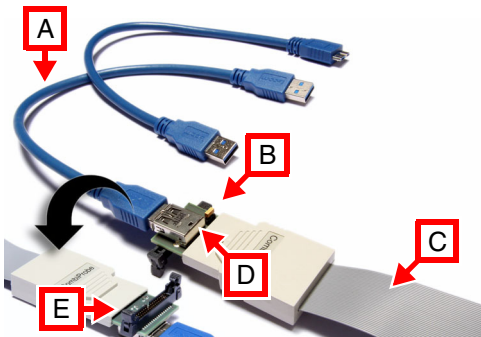

- A USB cable to target system
- B VBUS slider
- C Cable to CombiProbe

- D USB connector for target system
- E 34-pin expansion connector (proprietary)

DCI DbC allows debugging using the OS USB stack.

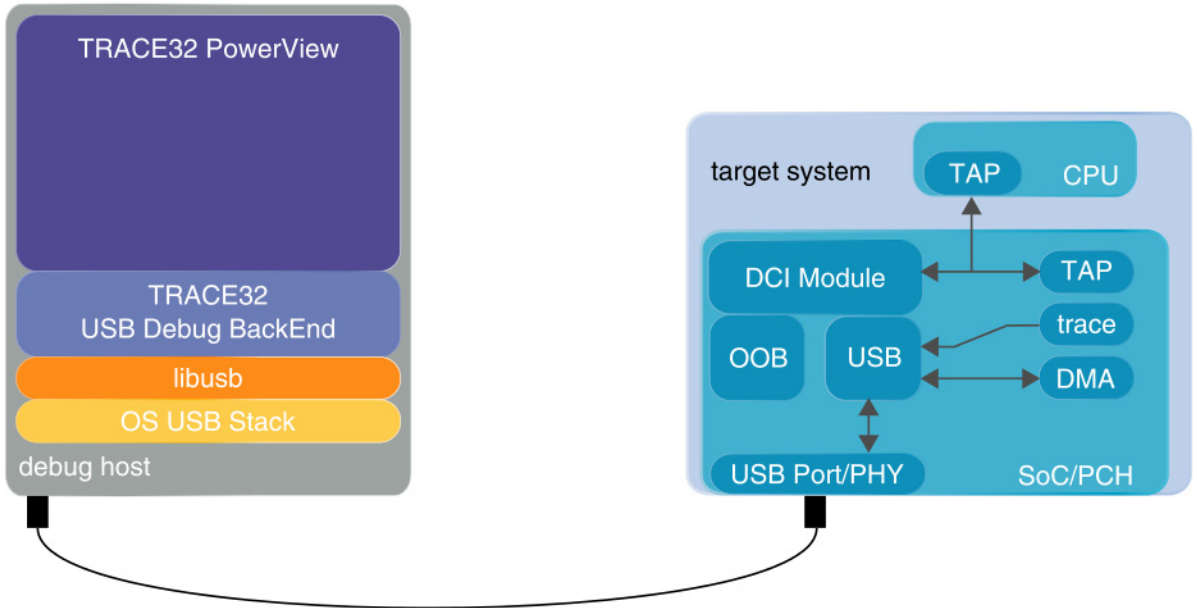

The figure above illustrates a typical setup. TRACE32 only runs on the debug host. The target system connects to the debug host using a USB cable.

TRACE32 sends DCI commands encoded in the USB protocol to the target system using libusb and the USB Stack of the operating system. In the target system the commands are decoded by the USB implementation and forwarded to the DCI module where they are translated to JTAG sequences. These JTAG sequences allow to access the internal TAP of the SoC/PCH as well as externally connected JTAG devices (e.g., the CPU of a client or server system).

Trace data can be directly exported via USB and recorded by TRACE32 on the debug host. DCI DbC also provides a DMA capability for fast download of the system RAM. Support of these capabilities by TRACE32 depends on the used target system.

For using DCI DbC, please observe the **“System Requirements”** (usbdebug_user.pdf).

Target System Requirements

For debugging using Intel® DCI your target system must fulfill the following:

- The BIOS must enable DCI debugging or provide a user option to do so. Please contact your BIOS manufacturer to clarify if your BIOS conforms to the *Intel® BIOS Writer's Guide* requirements for DCI support.
- For using DCI OOB, the USB part of your target system must be electrically designed such that DCI OOB signaling is not blocked. This is of special importance for USB Type-C solutions. Details about these requirements can be found in the appropriate *Intel® Platform Design Guide*.

Related Documents

- [“Intel® x86/x64 Debugger”](#) (debugger_x86.pdf)
- [“Debugging via USB User’s Guide”](#) (usbdebug_user.pdf)
- [“Intel® Trace Hub”](#) (trace_intel_th.pdf)

Prepare Your Target

Irrespective of which DCI variant is used, debugging via DCI needs to be activated in the BIOS of the target system first. Please contact your BIOS manufacturer for instructions.

Connecting to an Intel® SoC using DCI OOB

1. Connect your TRACE32 hardware and start the TRACE32 software, as described in [“Starting a TRACE32 PowerView Instance”](#) (training_debugger_x86.pdf).
2. For SoCs configure the CPU, e.g., by executing the following command:

```
SYStem.CPU APOLLOLAKE
```

3. Establish the debug connection:

```
SYStem.Attach
```

On a successful connect, the TRACE32 [state line](#) displays “running” or “cpu power down”:



You are now ready to debug the x86 core using DCI OOB. For information on how to continue, please refer to:

- [“Basic Debugging Intel® x86/x64”](#) (training_debugger_x86.pdf) or
- [“Intel® x86/x64 Debugger”](#) (debugger_x86.pdf)

Connecting to an Intel® Client or Server System using DCI OOB

1. Connect your TRACE32 hardware and start the TRACE32 software, as described in [“Starting a TRACE32 PowerView Instance”](#) (training_debugger_x86.pdf).
2. For client or server systems configure CPU, PCH, and core number e.g.:

```
SYStem.CONFIG PCH SUNRISEPOINT  
SYStem.DETEct CPU  
SYStem.DETEct CORES
```

The results are displayed in the [AREA.view](#) window:

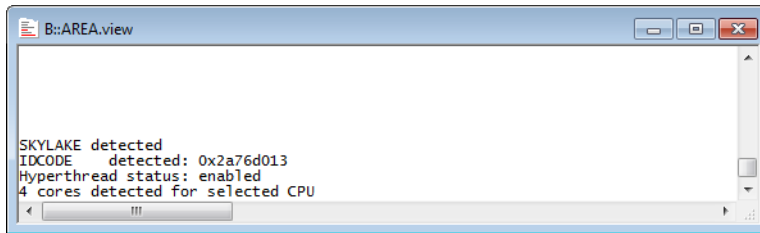

3. Establish the debug connection:

```
SYStem.Attach
```

On a successful connect, the TRACE32 [state line](#) displays “running” or “cpu power down”:



You are now ready to debug the x86 core using DCI OOB. For information on how to continue, please refer to:

- [“Basic Debugging Intel® x86/x64”](#) (training_debugger_x86.pdf) or
- [“Intel® x86/x64 Debugger”](#) (debugger_x86.pdf)

Connecting to an Intel® SoC using DCI DbC

1. Install the target USB driver and start a TRACE32 session for USB debugging as described in [“Debugging via USB User’s Guide”](#) (usbdebug_user.pdf).
2. For SoCs configure the CPU, e.g., by executing the following command:

```
SYStem.CPU APOLLOLAKE
```

3. Select the **IntelUSB0** debug port and configure the USB parameters for the debug connection, e.g., by executing the following commands:

```
SYStem.CONFIG DEBUGPORT IntelUSB0  
SYStem.CONFIG USB SETDEVICE Debug 1. 0x8087 0x0A73
```

In this example, “1.” is the number of the debug enabled interface, “0x8087” is the vendor ID of the target system and “0x0A73” is the product ID of the target system.

These parameters can be determined interactively as described in [“Select a USB Device via the GUI”](#) (usbdebug_user.pdf). For details, please refer to [SYSTEM.CONFIG.USB](#).

4. For tracing via DbC, add the configuration for the trace interface, e.g.:

```
SYStem.CONFIG USB SETDEVICE Trace 2. 0x08087 0x0A73
```

5. For using DMA via DbC, add the configuration for the DMA interface, e.g.:

```
SYStem.CONFIG USB SETDEVICE DMA 3. 0x08087 0x0A73
```

6. Establish the debug connection:

```
SYStem.Attach
```

On a successful connect, the TRACE32 [state line](#) displays “running” or “cpu power down”:



You are now ready to debug the x86 core using DCI DbC. For information on how to continue, please refer to:

- [“Basic Debugging Intel® x86/x64”](#) (training_debugger_x86.pdf) or
- [“Intel® x86/x64 Debugger”](#) (debugger_x86.pdf)

Connecting to an Intel® Client or Server System using DCI DbC

1. Install the target USB driver and start a TRACE32 session for USB debugging as described in [“Debugging via USB User’s Guide”](#) (usbdebug_user.pdf).
2. Configure the PCH your board is using, e.g., by executing the following command:

```
SYStem.CONFIG PCH SUNRISEPOINT
```

3. Configure the USB parameters for the debug connection, e.g., by executing the following commands:

```
SYStem.CONFIG DEBUGPORT IntelUSB0  
SYStem.CONFIG USB SETDEVICE Debug 1. 0x8087 0x0A6E
```

In this example, “1.” is the number of the debug enabled interface, “0x8087” is the vendor ID of the target system and “0x0A6E” is the product ID of the target system.

These parameters can be determined interactively as described in [“Select a USB Device via the GUI”](#) (usbdebug_user.pdf). For details, please refer to [SYSTEM.CONFIG.USB](#).

4. Run the following commands to detect CPU and core number automatically:

```
SYStem.DETECT CPU  
SYStem.DETECT CORES
```

The results are displayed in the [AREA.view](#) window:

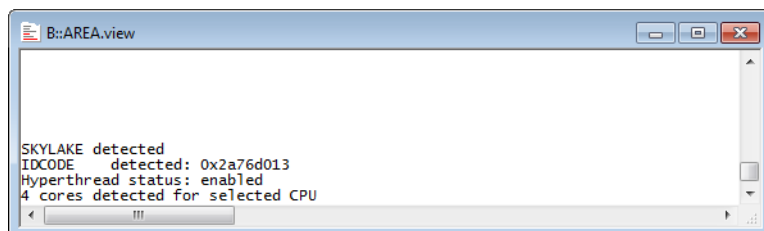

5. Establish the debug connection:

```
SYStem.Attach
```

On a successful connect, the TRACE32 [state line](#) displays “running” or “cpu power down”:



You are now ready to debug the x86 core using DCI DbC. For information on how to continue, please refer to:

- [“Basic Debugging Intel® x86/x64”](#) (training_debugger_x86.pdf) or
- [“Intel® x86/x64 Debugger”](#) (debugger_x86.pdf)

The following describes some possible error scenarios, along with suggestions how to resolve them:

DCI error: no response to connect pattern

TRACE32 did not receive any response from the target.

- Make sure the USB cable is connected to a DCI enabled USB port.
- Make sure DCI is enabled in the BIOS of the target system.
- Configure the DO-Routing manually. For details, see [SYStem.DCI.DOrouting](#).
- In case you are using a USB Type-C connector, try flipping the plug.
- Consider removing common mode chokes in the USB path.

Could not stop the target

TRACE32 could not halt the processor, but the DCI connection is working.

- Make sure debugging is enabled in the BIOS of the target system.

Target Power Fail

Using DCI TRACE32 cannot detect whether the target system is powered. Thus all connection losses are interpreted as power fails. In case you are encountering target power fails, but your target system is powered:

- Try a lower DCI OOB clock. For details, see [SYStem.DCI.BssbClock](#).
- Consider removing common mode chokes in the USB path.

DCI

Commands to configure the Intel® DCI trace handler

The Intel® DCI trace handler is a hardware module of the Intel® DCI implementation on the target system. This module is responsible for forwarding trace data coming from the Intel® Trace Hub to a DCI transport.

The **DCI** command group allows expert control of this hardware module. If using the Intel® Trace Hub commands this configuration is done automatically (see **ITH** commands).

See also

■ [DCI.DESTination](#)

■ [DCI.OFF](#)

■ [DCI.ON](#)

■ [SYStem.DCI](#)

DCI.DESTination

Set trace destination

Format: **DCI.DESTination [OOB | DBC]**

Configures to which destination the trace data is routed.

OOB (default) Stream the trace data to the Intel® DCI OOB interface.

DBC Stream the trace data to the Intel® DCI DbC interface (USB).

See also

■ [DCI](#)

DCI.ON

Enable trace handler

Format: **DCI.ON**

Enables the trace handler.

See also

■ [DCI](#)

Format: **DCI.OFF**

Disables the trace handler.

See also

- [DCI](#)

Using the **SYStem.DCI** command group, you can configure target properties as well as the DCI OOB hardware.

See also

- SYStem.DCI.Bridge
 - SYStem.DCI.BssbClock
 - SYStem.DCI.CKDIrouting
 - SYStem.DCI.DisCONNECT
 - SYStem.DCI.DORouting
 - SYStem.DCI.PortPower
 - SYStem.DCI.TimeOut
 - SYStem.state
 - DCI
 - SYStem.DCI.Bridge()
 - SYStem.DCI.BssbClock()
- ▲ 'Intel® DCI Specific Functions' in 'Debugging via Intel® DCI User's Guide'

SYStem.DCI.Bridge

Select DCI bridge

Format: **SYStem.DCI.Bridge** *<bridge_name>*

Configures TRACE32 for the specific DCI bridge implementation used in your system. For known Intel® SoCs and PCHs this setting is done automatically based on CPU/PCH settings.

See also

- SYStem.DCI
- SYStem.DCI.Bridge()

SYStem.DCI.BssbClock

Configure DCI OOB clock rate

Format: **SYStem.DCI.BssbClock** *<frequency>* [*<slow_frequency>*]

Configures the operating frequency used by the TRACE32 DCI OOB hardware. The maximum frequency is 100 MHz.

<frequency> Frequency during normal operation. Default: 100MHz.

<slow_frequency> Frequency used during connect and during low power phases. The default is based on the selected platform.

Example: Set frequency to 50 MHz.

```
SYStem.DCI.BssbClock 50.MHz
```

See also

- [SYStem.DCI](#)
- [SYStem.DCI.BssbClock\(\)](#)

SYStem.DCI.CKDIrouting

Routing of the CK and DI signals

Format: **SYStem.DCI.CKDIrouting [STRAIGHTthrough | CROSSover]**

Configures how the CK and DI signals are mapped to the super speed rx signals on the USB 3 connector of the target. This configuration option is available for 4-wire DCI OOB only. The configuration must be set before trying to connect.

- | | |
|------------------------|--|
| STRAIGHTthrough | The signals CK and DI are routed in compliance with the Intel DCI specification. Set if the rx signals are connected one-to-one from the chip to the USB port. |
| CROSSover | The signals CK and DI are routed contrary to the Intel DCI specification. Set if the rx signals are connected cross-over from the chip to the USB port. |

See also

- [SYStem.DCI](#)

SYStem.DCI.DisCONNECT

Force DCI disconnect

Format: **SYStem.DCI.DisCONNECT**

Terminates the low-level DCI connection.

Normally TRACE32 will manage the connect and disconnect of the DCI connection used for the debug session automatically. However, in some cases explicit termination of the DCI connection is required, e.g., when TRACE32 is used together with the T32 Remote API.

NOTE: **SYStem.DCI.DisCONnect** will not care about the overall state of your debug session before disconnecting.
To avoid problems, execute **SYStem.Down** on all TRACE32 instances before executing this command.

See also

■ [SYStem.DCI](#)

SYStem.DCI.DOrouting

Routing of the DO signals

Format: **SYStem.DCI.DOrouting** [AUTO | STRAIGHTthrough | CROSSover]

Configures how the DO signal pair is mapped to the super speed tx signals on the USB 3 connector of the target. This configuration option is available for 4-wire DCI OOB only. The configuration must be set before trying to connect.

AUTO (default)	TRACE32 tries to detect the routing automatically.
STRAIGHTthrough	The signals DO+ and DO- are routed in compliance with the Intel DCI specification. Set if the tx signals are connected one-to-one from the chip to the USB port.
CROSSover	The signals DO+ and DO- are routed opposed to the Intel DCI specification. Set if the tx signals are connected cross-over from the chip to the USB port.

See also

■ [SYStem.DCI](#)

```

Format:          SYStem.DCI.PortPower <mode>

<mode>:         OFF
                 DIScharge
                 SDP
                 CDP
                 DCPAUTO
                 DCPBC12
                 DCPDIV

```

Some TRACE32 DCI OOB hardware can drive the VBUS pin of the USB port from the debugger and emulate a USB charging port.

Preconditions:

- Base module is PowerDebug USB3.0 or PowerDebug Pro.
- [“Whisker Cable DCI OOB for CombiProbe Version 2”](#), page 5.
- The yellow slider on the CombiProbe Whisker must be set to on.

The following modes are available:

OFF (default)	Do not drive VBUS.
DIScharge	Discharge VBUS.
SDP	Standard Downstream Port according to the USB2.0 specification.
CDP	Charging Downstream Port according to the USB 2.0 BC1.2 specification.
DCPauto	Dedicated Charging Port In this mode the used DCP scheme is automatically detected.
DCPBC12	Dedicated Charging Port according to USB 2.0 BC1.2 specification.
DCPDIV	Dedicated Charging Port - Divider Mode D+ and D- of the USB port are driven to 2V and 2.7V, respectively.

See also

- SYStem.DCI

Format: **SYStem.DCI.TimeOut** *<operation>* *<time>*

<operation>:
SETtings
JTAG
PMChandshake

Configure the timeout for certain internal operations. Do not change unless instructed to do so by the Lauterbach support.

The current value can be obtained using the **SYStem.DCI.TimeOut()** function.

See also

■ [SYStem.DCI](#)

□ [SYStem.DCI.TIMEOUT\(\)](#)

In This Section

See also

■ [SYStem.DCI](#) □ [SYStem.DCI.Bridge\(\)](#) □ [SYStem.DCI.BssbClock\(\)](#) □ [SYStem.DCI.TIMEOUT\(\)](#)

SYStem.DCI.Bridge()

Currently selected DCI bridge

[build 68208 - DVD 09/2016]

Syntax: **SYStem.DCI.Bridge()**

Returns the name of the currently selected DCI bridge. The bridge is selected with the **SYStem.DCI.Bridge** command.

Return Value Type: [String](#).

Example:

```
PRINT SYStem.DCI.Bridge()
```

SYStem.DCI.BssbClock()

Currently selected DCI OOB clock

[build 68208 - DVD 09/2016]

Syntax: **SYStem.DCI.BssbClock(<clock_name>)**

<clock_name>: **ACTIVE | DEFault | SLOW**

Returns the value of the current DCI OOB clock rate. The clock rate is configured with the **SYStem.DCI.BssbClock** command.

Parameter Type: [String](#).

ACTIVE	The currently active DCI OOB clock.
DEFault	The value of the DCI OOB clock used during normal operation.
SLOW	The value of the DCI OOB clock used during connect and low power phases.

Return Value Type: [Decimal value](#).

Example:

```
PRINT SYStem.DCI.BssbClock(ACTIVE)
```

SYStem.DCI.TIMEOUT()

Timeouts of internal operations

[build 79617 - DVD 02/2017]

Syntax: **SYStem.DCI.TIMEOUT**(<operation>)

<operation>: **JTAG** | **SETtings** | **PMChandshake**

Returns the current timeout of an internal operation. The timeout can be configured using the **SYStem.CONFIG DCI.TimeOut** command.

Parameter Type: [String](#).

Return Value Type: [Time value](#).